



PETTITI GIUSEPPE s.p.a.

SERIE MONOSILENT

PORTATA	Per coppia di carrelli
CAPACITY	For each pair of trolleys
PORTEE	Pour couple de chariots
	a 4 cuscinetti
	with 4 bearings
	à 4 coussinets
Kg 600	

CARRELLI ED ACCESSORI PER MONOROTAIA MS600/NA

TROLLEYS AND ACCESSORIES FOR RAIL MS600/NA

CHARIOTS ET ACCESSOIRES POUR MONORAIL MS600/NA

MONOROTAIA IN ALLUMINIO GREZZO

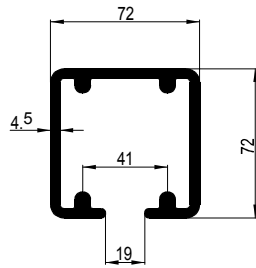

MS 600/NA Monorotaia in alluminio grezzo

Lunghezza = 6 m
Length = 6 m
Longueur = 6 m

Rail in aluminium.
Monorail en aluminium.

ART.	Confez. Box	Peso Kg Weight	
MS 600/NA	24 m n° 4x6 m	Kg/m 3,510	

CARRELLO FISSO CENTRALE A 4 RUOTE IN NYLON

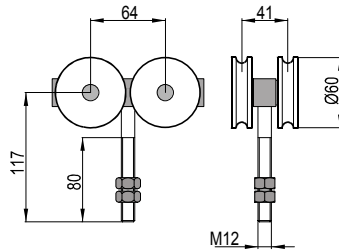

Central fix trolley with 4 wheels in nylon.
Chariot fixe à 4 roulements, en nylon.

ART.	Confez. Box	Peso Kg Weight	
4S600	6	1,100	

CARRELLO FISSO CENTRALE A 4 RUOTE IN NYLON

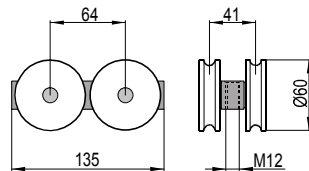

Central fix trolley with 4 wheels in nylon.
Chariot fixe à 4 roulements, en nylon.

Perno centrale eseguibile su richiesta.
Central pin feasible on request.
Pivot central exécutable sur demande.

ART.	Confez. Box	Peso Kg Weight	
CA/M600	6	0,950	

PIASTRA GIREVOLE IN ACCIAIO SU SFERE

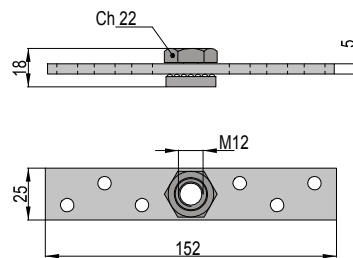

Rotating plate in zinked steel on balls.
Platine articulée en acier zingué sur billes.

ART.	Confez. Box	Peso Kg Weight	
210S	50	0,170	

PIASTRA FISSA CON OLIVA GIREVOLE IN OTTONE

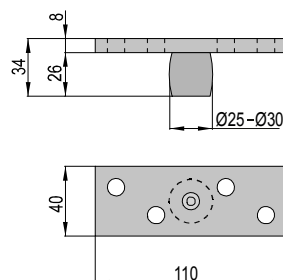

Fix plate with rotating olive in brass.
Platine fixe avec olive articulée en laiton.

ART.	Confez. Box	Peso Kg Weight	
309/25	25	0,340	
309/30	25	0,380	

FERMO IN ALLUMINIO CON PARACOLPO

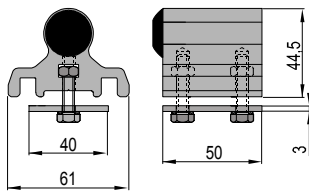

Back stop in aluminium with rubber buffer.

Ferme d'arrêt en aluminium avec butoir en gomme.

ART.	Confez. Box	Peso Kg Weight
460	6	0,290

SUPPORTO A PARETE IN ALLUMINIO GREZZO

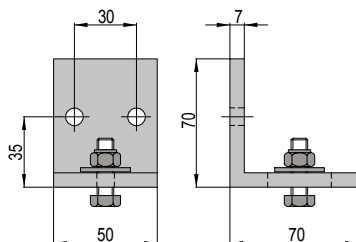

Wall support in rough aluminium.

Support a pard en aluminium brut.

ART.	Confez. Box	Peso Kg Weight
LS 600	10	0,140

GUIDA INFERIORE IN ALLUMINIO GREZZO

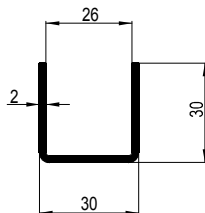

Lunghezza = 6 m

Length = 6 m

Longueur = 6m

Lower guide in rough aluminium.

Guide inferieure en aluminium brut.

ART.	Confez. Box	Peso Kg Weight
GI600	36 m n° 6x6 m	Kg/m 0,464

SET



Set in contenitore di cartone per monorotaia MS600/NA composto da:
n. 2 carrelli (art. 4S600)
n. 2 piastre girevoli (art. 210S)
n. 2 fermi d'arresto (art. 460)
n. 1 piastra fissa (art. 309/25)

Set in carton box for rail MS600/NA including:
n. 2 trolleys (art. 4S600)
n. 2 rotating plates (art. 210S)
n. 2 backstop (art. 460)
n. 1 fixed plate (art. 309/25)

Set en boîte de carton pour monorail MS600 composé par:
n. 2 chariots (art. 4S600)
n. 2 platines articulées (art. 210S)
n. 2 fermes d'arrêt (art. 460)
n. 1 platine fixe (art. 309/25)

ART.	Confez. Box	Peso Kg Weight
S 600	1	3,460

S 200 - S 300 - S 600 - Fissaggio a parete

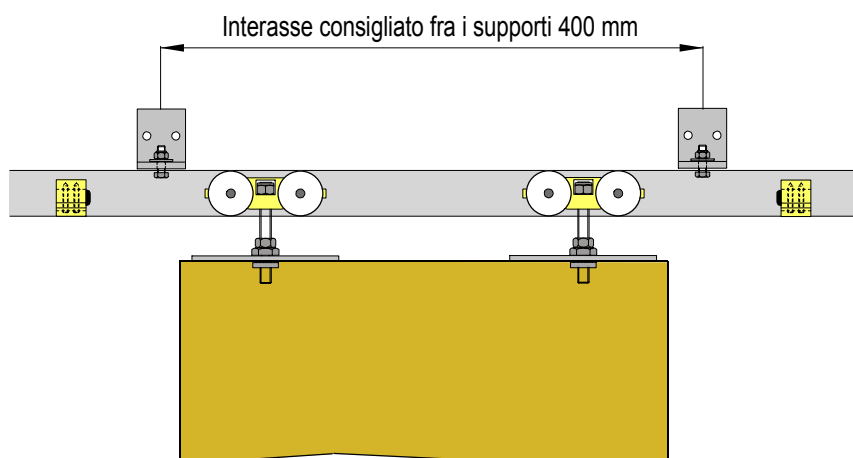



PETTITI GIUSEPPE s.p.a.

SERIE MONOSILENT

PORTATA	Per coppia di carrelli
CAPACITY	For each pair of trolleys
PORTEE	Pour couple de chariots
	a 4 cuscinetti
	with 4 bearings
	à 4 coussinets
Kg 300	

CARRELLI ED ACCESSORI PER MONOROTAIA MS300/NA

TROLLEYS AND ACCESSORIES FOR RAIL MS300/NA

CHARIOTS ET ACCESSOIRES POUR MONORAIL MS300/NA

MONOROTAIA IN ALLUMINIO GREZZO

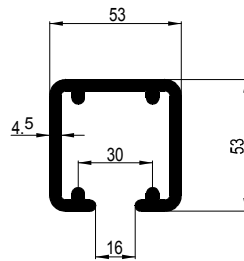

MS 300/NA Monorotaia in alluminio grezzo

Lunghezza = 6 m
Length = 6 m
Longueur = 6 m

Rail in aluminium.
Monorail en aluminium.

ART.	Confez. Box	Peso Kg Weight	
MS 300/NA	36 m n° 6x6 m	Kg/m 2,310	

CARRELLO FISSO CENTRALE A 4 RUOTE IN NYLON

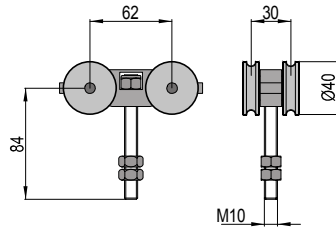

In alluminio.
In aluminium.
En aluminium.

Central fix trolley with 4 wheels in nylon.
Chariot fixe à 4 roulements, en nylon.

ART.	Confez. Box	Peso Kg Weight	
4S300	12	0,270	

CARRELLO FISSO CENTRALE A 4 RUOTE IN NYLON

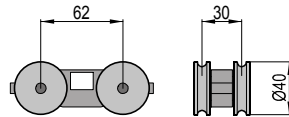

In alluminio.
In aluminium.
En aluminium.

Central fix trolley with 4 wheels in nylon.
Chariot fixe à 4 roulements, en nylon.

ART.	Confez. Box	Peso Kg Weight	
CA/M300	12	0,240	

PIASTRA GIREVOLE IN ACCIAIO SU SFERE

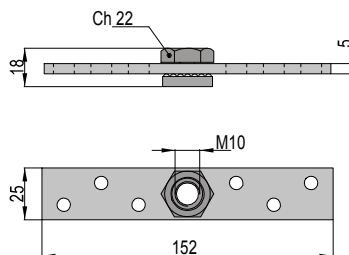

Rotating plate in zinked steel on balls.
Platine articulée en acier zingue sur billes.

ART.	Confez. Box	Peso Kg Weight	
300S	30	0,170	

PIASTRA FISSA CON OLIVA GIREVOLE IN OTTONE

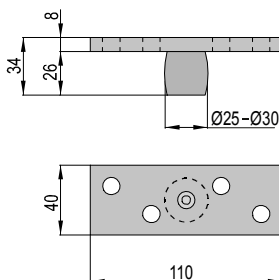

Fix plate with rotating olive in brass.
Platine fixe avec olive articulée en laiton.

ART.	Confez. Box	Peso Kg Weight	
309/25	25	0,340	
309/30	25	0,380	

FERMO IN ALLUMINIO CON PARACOLPO

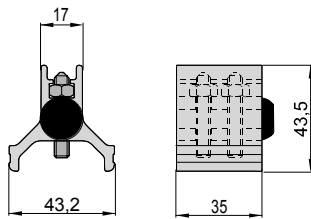

Back stop in aluminium with rubber buffer.
Ferme d'arrêt en aluminium avec butoir en gomme.

ART.	Confez. Box	Peso Kg Weight
430	12	0,065

SUPPORTO A PARETE IN ALLUMINIO GREZZO

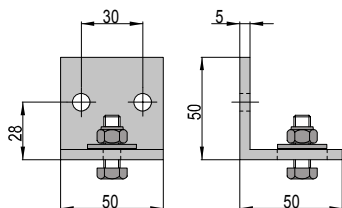

Wall support in rough aluminium.
Support à pard en aluminim brut.

ART.	Confez. Box	Peso Kg Weight
LS 300	12	0,085

GUIDA INFERIORE IN ALLUMINIO GREZZO

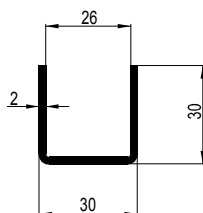

Lunghezza = 6 m
Length = 6 m
Longueur = 6m

Lower guide in rough aluminium.
Guide inferieure en aluminium brut.

ART.	Confez. Box	Peso Kg Weight
GI600	36 m n° 6x6 m	Kg/m 0,464

SET



Set in contenitore di cartone per monorotaia MS300/NA composto da:
n. 2 carrelli (art. 4S300)
n. 2 piastre girevoli (art. 300S)
n. 2 fermi d'arresto (art. 430)
n. 1 piastra fissa (art. 309/25)

Set in carton box for rail MS300/NA including:
n. 2 trolleys (art. 4S300)
n. 2 rotating plates (art. 300S)
n. 2 backstop (art. 430)
n. 1 fixed plate (art. 309/25)

Set en boîte de carton pour monorail MS300/NA composé par:
n. 2 chariots (art. 4S300)
n. 2 platines articulée (art. 300S)
n. 2 fermes d'arret (art. 430)
n. 1 platine fixe (art. 309/25)

ART.	Confez. Box	Peso Kg Weight
S 300	6	1,385

S 200 - S 300 - S 600 Fissaggio a soffitto

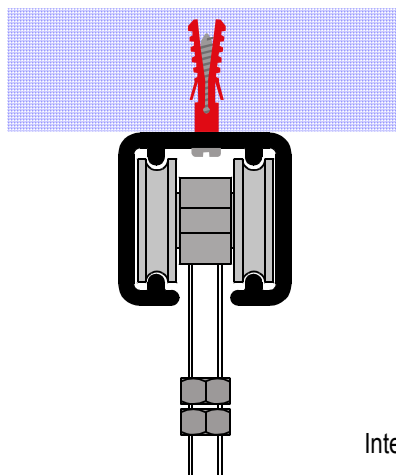

Interasse foratura consigliato 200 mm



PETTTI GIUSEPPE s.p.a.

SERIE MONOSILENT

PORTATA	Per coppia di carrelli
CAPACITY	For each pair of trolleys
PORTEE	Pour couple de chariots a 4 cuscinetti
Kg 200	with 4 bearings à 4 coussinets

CARRELLI ED ACCESSORI PER MONOROTAIA MS 200

TROLLEYS AND ACCESSORIES FOR RAIL MS 200

ACCESSOIRES POUR MONORAIL MS 200

MONOROTAIA IN ALLUMINIO GREZZO E ANODIZZATO

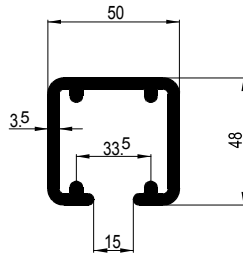
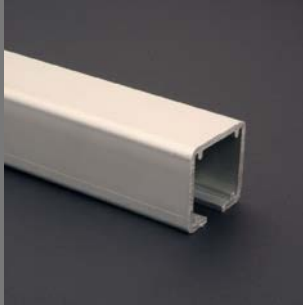

MS 200	Monorotaia in alluminio anodizzato
MS 200/NA	Monorotaia in alluminio grezzo

Lunghezza = 6 m
Length = 6 m
Longueur = 6 m

Rail in anodized and rough aluminium, trolleys ϕ 36.
Monorail en aluminium brut pour chariots ϕ 36.

ART.	Confez. Box	Peso Kg Weight
MS 200	54 m n° 9x6 m	Kg/m 1,680
MS 200/NA	54 m n° 9x6 m	Kg/m 1,680

CARRELLO FISSO IN ALLUMINIO A 4 RUOTE

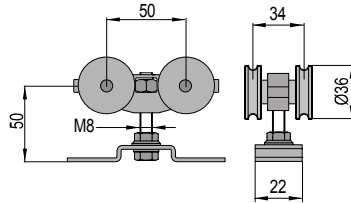

Fix trolley in aluminium ,with 4 wheels.
Chariot fixe en aluminium à 4 roulements.

4S200/INOX: staffa in acciaio inox. Consigliato per applicazioni esterne.
4S200/INOX: bracket en inox. Recommended for outside use.
4S200/INOX: platine en inox. Recommandé pour applications a l'extérieures.

INOX - STAINLESS

ART.	Confez. Box	Peso Kg Weight
4S200	12	0,251
4S200/INOX	12	0,251

SUPPORTO A PARETE IN ALLUMINIO GREZZO

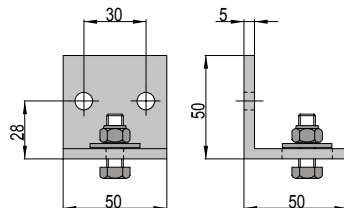

Wall support in rough aluminium.
Support a pard en aluminium brut.

ART.	Confez. Box	Peso Kg Weight
LS 300	12	0,085

PIASTRA FISSA CON OLIVA GIREVOLE

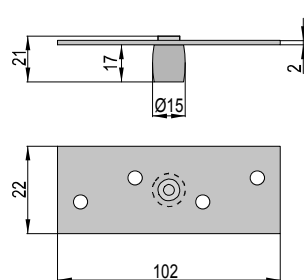

Fix plate with rotating olive.
Platine fixe avec olive articulée.

310	Piastra in acciaio zincato, oliva in ottone. Plate in zinked steel, olive in brass. Platine en acier zingué, olive en laiton.
310N/INOX	Piastra in acciaio inox, oliva in nylon. Plate in stainless steel, olive in nylon. Platine en acier inox, olive en nylon.

INOX - STAINLESS

ART.	Confez. Box	Peso Kg Weight
310	50	0,055
310N/INOX	50	0,055

FERMO DI FINE CORSA IN ALLUMINIO CON PARACOLPO

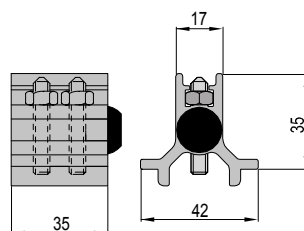

Back stop in aluminium with rubber buffer.
Ferme d'arrêt en aluminium avec butoir en gomme.

420/INOX: viti in acciaio inox. Consigliato per applicazioni esterne.
420/INOX: screws en inox. Recommended for outside use.
420/INOX: vis en inox. Recommandé pour applications a l'extérieures.

INOX - STAINLESS

ART.	Confez. Box	Peso Kg Weight
420	12	0,059
420/INOX	12	0,059

FERMO DI FINE CORSA IN ALLUMINIO CON RITENUTA, REGOLABILE

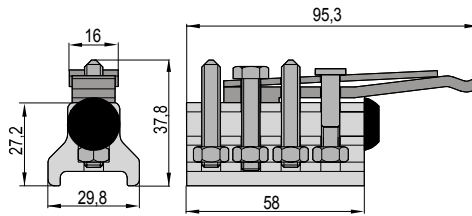

Back stop in aluminium with restraint, adjustable

Ferme d'arrêt en aluminium avec retenue, réglable

420R/INOX: viti in acciaio inox. Consigliato per applicazioni esterne.
420R/INOX: screws en inox. Recommended for outside use.
420R/INOX: vis en inox. Recommandé pour applications a l'extérieures.

ART.	Confez. Box	Peso Kg Weight	
420R	12	0,107	
INOX - STAINLESS 420R/INOX	12	0,107	

GUIDA INFERIORE IN ALLUMINIO GREZZO

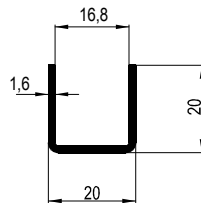

Lunghezza = 6 m
Length = 6 m
Longueur = 6 m

Lower guide in rough aluminium.
Guide inferieure en aluminium brut.

ART.	Confez. Box	Peso Kg Weight	
GIM	72 m n° 12x6 m	Kg/m 0,235	

SET



Set in contenitore di cartone per monorotaia MS200/NA - MS200 composto da:
n. 2 carrelli completi
n. 2 fermi d'arresto
n. 1 guida inferiore (art. 310)
viti di fissaggio

Set in carton box for rail MS200/NA - MS200 including:
n. 2 complete trolleys
n. 2 backstop
n. 1 lower guide (art. 310)
fixing screws

Set en boite de carton pour monorail MS200/NA - MS200 composé de:
n. 2 chariots
n. 2 fermes d'arrêt
n. 1 guide inferieure (art.310)
vis de fixation

4S200/INOX: staffa in acciaio inox. Consigliato per applicazioni esterne.
4S200/INOX: bracket en inox. Recommended for outside use.
4S200/INOX: platine en inox. Recommandé pour applications a l'extérieures.

ART.	Confez. Box	Peso Kg Weight	
S 200	6	0,775	
INOX - STAINLESS S 200/INOX	6	0,775	

Esempio di applicazione dello stop con ritenuta 420R - 420R/INOX

Application example of stop with restraint 420R - 420R/INOX

Exemple d'application des ferme avec retenue 420R - 420R/INOX

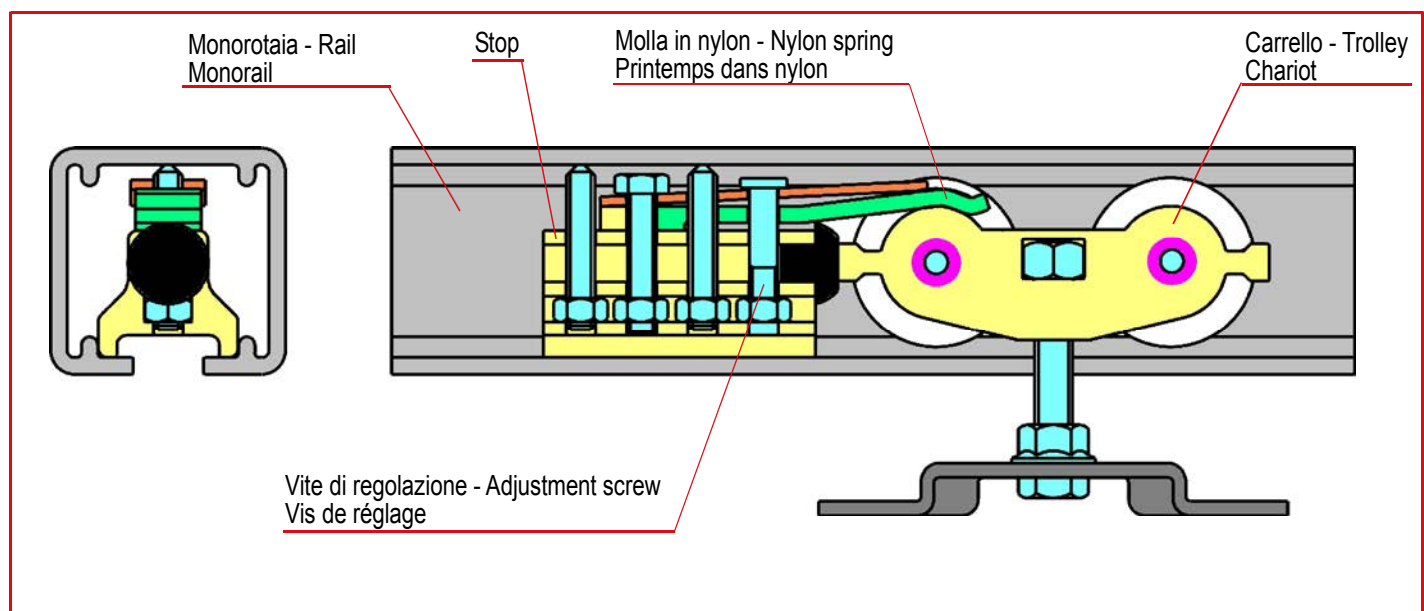

L'applicazione è valida per le serie da 200, 300 e 600 Kg.

The application is valid for 200, 300 and 600 Kg. series.

L'application est valide pour les séries de 200, 300 et 600 Kg.

